

Part number

TAVW 10 G32



Hood, T-TYPE /W series, with 2 levers, M32 top cable entry, size "57.27"

Product description

Product type	Hood
Series	T-TYPE /W
Closing type	With 2 levers
Size	Size "57.27"
Cable entry	Top cable entry with adapter M32

Technical data

IP degree of protection	IP65 / IP66 / IP69
--------------------------------	--------------------

Further technical details

Weight	125,00 g
Operating temperature range (min, max)	-40°C ... +90°C

Material properties

Main material	Polypropylene (PP)
Other materials	Lever: polyamide (PA) Gasket: FKM
Colour	RAL 7012 grey, RAL 7001 grey
RoHs conformity	Compliant
China RoHs - EFUP	E
REACH SVHC substances	No

Approvals / Standards

UL	ECBT2
cUL	ECBT8

General ordering information

EAN13 code	8015747212199
eCl@ss 8.1	27440202
ETIM 7.0	EC000437

Packaging Information

Packaging length	310,00 mm
Packaging height	220,00 mm
Packaging width	240,00 mm
Packaging weight	2,61 kg
Packaging volume	16,37 dm ³
Packaging description	Carton box
Packaging quantity	20 Pcs
Packaging EAN code	8015747261012
Sub-packaging weight	0,65 kg
Sub-packaging description	Plastic packaging
Sub-packaging quantity	5 Pcs
Sub-packaging EAN barcode	8015747212366

Part number

TAVW 10 G32



Catalogue drawings

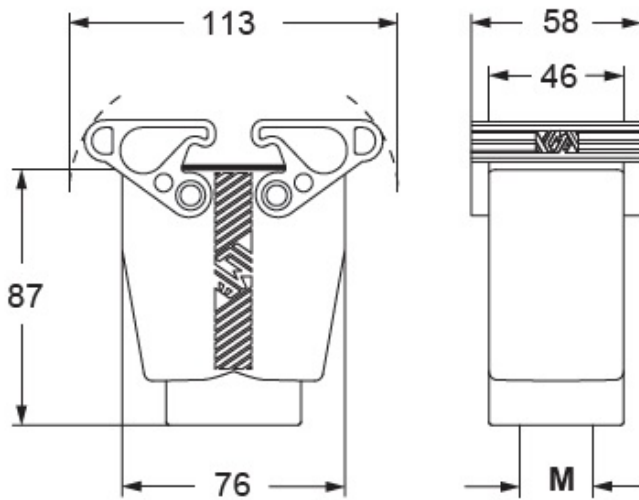

Notes

Dimensions shown in mm are not binding and may be changed without notice.