

Part number

TAPC 24.32



Surface mounting housing, T-TYPE/C series, with 2 levers, M32 cable entry, size "104.27"

Product description

| | |
|---------------------|--------------------------|
| Product type | Surface mounting housing |
| Series | T-TYPE/C |
| Closing type | With 2 levers |
| Size | Size "104.27" |
| Cable entry | M32 |

Technical data

| | |
|--------------------------------|--------------------|
| IP degree of protection | IP65 / IP66 / IP69 |
|--------------------------------|--------------------|

Further technical details

| | |
|---|-----------------|
| Weight | 192,00 g |
| Operating temperature range (min, max) | -50°C ... +70°C |

Material properties

| | |
|------------------------------|--|
| Main material | Polypropylene (PP) |
| Other materials | Lever: polypropylene (PP) Gasket: silicone rubber |
| Colour | RAL 7012 grey, RAL 5005 blue |
| RoHS conformity | Compliant |
| China RoHS - EFUP | E |
| REACH SVHC substances | No |

General ordering information

| | |
|-------------------|---------------|
| EAN13 code | 8015747211987 |
| eCl@ss 8.1 | 27440202 |
| ETIM 7.0 | EC000437 |

Packaging Information

| | |
|----------------------------------|-----------------------|
| Packaging length | 330,00 mm |
| Packaging height | 220,00 mm |
| Packaging width | 310,00 mm |
| Packaging weight | 4,23 kg |
| Packaging volume | 22,51 dm ³ |
| Packaging description | Carton box |
| Packaging quantity | 20 Pcs |
| Packaging EAN code | 8015747212120 |
| Sub-packaging weight | 1,06 kg |
| Sub-packaging description | Plastic packaging |
| Sub-packaging quantity | 5 Pcs |
| Sub-packaging EAN barcode | 8015747212137 |

Part number

TAPC 24.32



Catalogue drawings

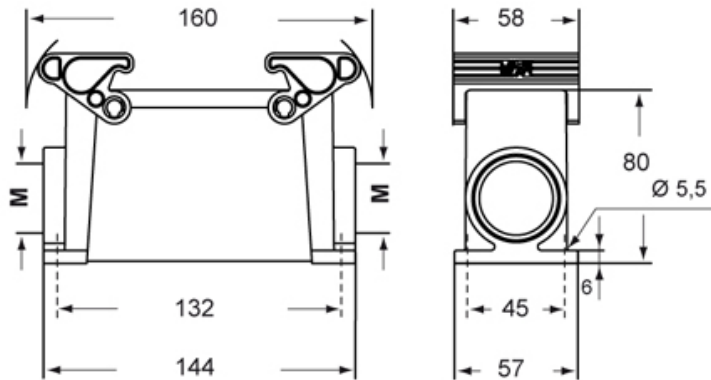

Notes

Dimensions shown in mm are not binding and may be changed without notice.