

Part number

MVAP 06LSP32



Surface mounting housing, V-TYPE series, with 1 lever, M32 cable entry, size "44.27", high construction, with SIMPLEX self-closing cover

Product description

Product type	Surface mounting housing
Series	V-TYPE
Closing type	With 1 lever
Size	Size "44.27"
Cable entry	M32
Specification	High construction, with SIMPLEX self-closing cover

Technical data

IP degree of protection	IP65
--------------------------------	------

Further technical details

Weight	450,00 g
Operating temperature range (min, max)	-40°C...+125°C

Material properties

Colour	RAL 7040 grey
RoHs conformity	Compliant
China RoHs - EFUP	E
REACH SVHC substances	No

Approvals / Standards

Certifications	DNV, BV
UL	ECBT2
cUL	ECBT8

General ordering information

EAN13 code	8015747229425
eCl@ss 8.1	27440202
ETIM 7.0	EC000437

Packaging Information

Packaging weight	4,50 kg
Packaging volume	13,97 dm ³
Packaging description	Carton box
Packaging quantity	10 Pcs
Packaging EAN code	8015747229562
Sub-packaging weight	2,25 kg
Sub-packaging description	Plastic packaging
Sub-packaging quantity	5 Pcs
Sub-packaging EAN barcode	8015747229579

Part number

MVAP 06LSP32



Catalogue drawings

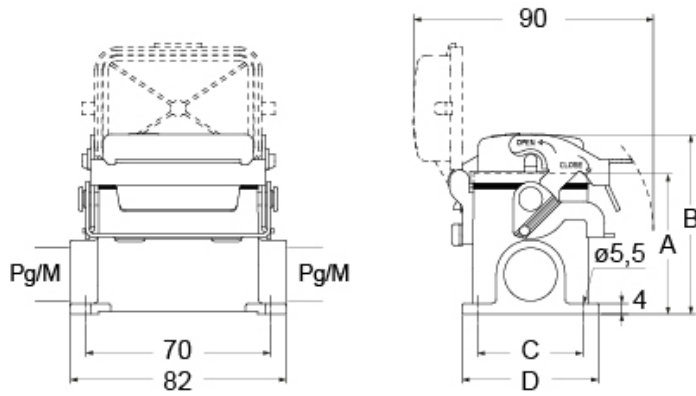

part No.	A	B	C	D
CVP / MVP 6 LSP	53	68	40	52
CVAP / MVAP 6 LSP	74	89	45	57

Notes

Dimensions shown in mm are not binding and may be changed without notice.