

Part number

MHV 16 X32



Hood, C-TYPE series, with 2 levers, M32 top cable entry, size "77.27", without gasket

Product description

Product type	Hood
Series	C-TYPE
Closing type	With 2 levers
Size	Size "77.27"
Cable entry	Top cable entry with adapter M32
Specification	Without gasket

Technical data

IP degree of protection	IP65 / IP66 / IP69
--------------------------------	--------------------

Further technical details

Weight	210,00 g
Operating temperature range (min, max)	-40°C...+125°C

Material properties

Colour	RAL 7040 grey
RoHs conformity	Compliant
China RoHs - EFUP	E
REACH SVHC substances	No

Approvals / Standards

Certifications	DNV, BV
UL	ECBT2
cUL	ECBT8

General ordering information

EAN13 code	8015747055871
eCl@ss 8.1	27440202
ETIM 7.0	EC000437

Packaging Information

Packaging length	130,00 mm
Packaging height	145,00 mm
Packaging width	300,00 mm
Packaging weight	2,45 kg
Packaging volume	5,66 dm ³
Packaging description	Carton box
Packaging quantity	10 Pcs
Packaging EAN code	8015747055888
Sub-packaging weight	1,23 kg
Sub-packaging description	Plastic packaging
Sub-packaging quantity	5 Pcs
Sub-packaging EAN barcode	8015747055895

Part number

MHV 16 X32



Catalogue drawings

CHO X (CAO X) - MHO X (MAO X)

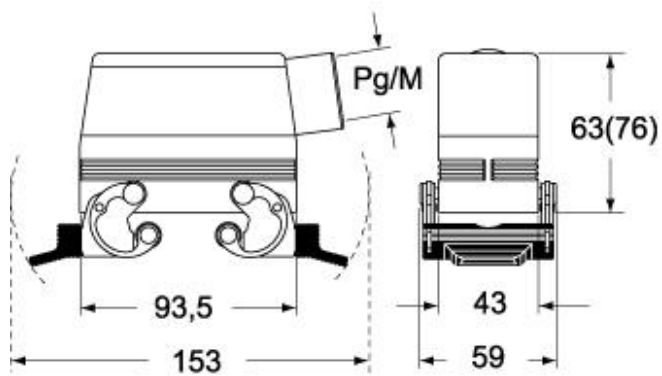

CHV X (CAV X) - MHV X (MAV X)

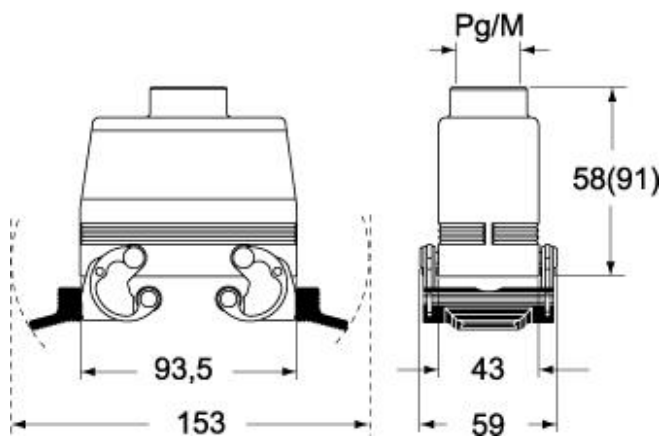

Notes

Dimensions shown in mm are not binding and may be changed without notice.