

Part number

# MGV 16.32



Hood, IP68 series, with 2 screws, M32 top cable entry, size "77.27"

#### Product description

<b>Product type</b>	Hood
<b>Series</b>	IP68
<b>Closing type</b>	With 2 screws
<b>Size</b>	Size "77.27"
<b>Cable entry</b>	Top cable entry with adapter M32

#### Technical data

<b>IP degree of protection</b>	IP66 / IP68 / IP69
--------------------------------	--------------------

#### Further technical details

<b>Weight</b>	472,50 g
<b>Operating temperature range (min, max)</b>	-40°C...+125°C

#### Material properties

<b>Main material</b>	Aluminium die-cast
<b>Colour</b>	RAL 9005 black
<b>RoHs conformity</b>	Compliant
<b>China RoHs - EFUP</b>	E
<b>REACH SVHC substances</b>	No

#### Approvals / Standards

<b>Certifications</b>	DNV, BV
<b>UL</b>	ECBT2
<b>cUL</b>	ECBT8

#### General ordering information

<b>EAN13 code</b>	8015747142342
<b>eCl@ss 8.1</b>	27440202
<b>ETIM 7.0</b>	EC000437

#### Packaging Information

<b>Packaging length</b>	175,00 mm
<b>Packaging height</b>	135,00 mm
<b>Packaging width</b>	130,00 mm
<b>Packaging weight</b>	1,04 kg
<b>Packaging volume</b>	3,07 dm <sup>3</sup>
<b>Packaging description</b>	Carton box
<b>Packaging quantity</b>	2 Pcs
<b>Packaging EAN code</b>	8015747143059
<b>Sub-packaging weight</b>	0,52 kg
<b>Sub-packaging description</b>	Plastic packaging
<b>Sub-packaging quantity</b>	1 Pcs
<b>Sub-packaging EAN barcode</b>	8015747143066

Part number

# MGV 16.32



Catalogue drawings

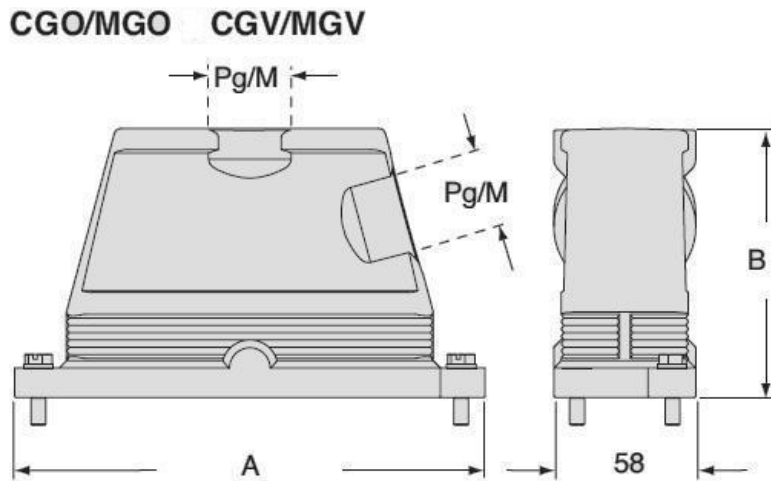

		A	B
CGO/MGO	CGV/MGV 06	133	101
CGO/MGO	CGV/MGV 10	146	101
CGO/MGO	CGV/MGV 16	166	111
CGO/MGO	CGV/MGV 24	193	111

## Notes

Dimensions shown in mm are not binding and may be changed without notice.