

Part number

# MGV 10.32 B



Hood, IP68 series, with 2 bayonets, M32 top cable entry, size "57.27"

#### Product description

<b>Product type</b>	Hood
<b>Series</b>	IP68
<b>Closing type</b>	With 2 bayonets
<b>Size</b>	Size "57.27"
<b>Cable entry</b>	Top cable entry with adapter M32

#### Technical data

<b>IP degree of protection</b>	IP66 / IP68 / IP69
--------------------------------	--------------------

#### Further technical details

<b>Weight</b>	390,00 g
<b>Operating temperature range (min, max)</b>	-40°C...+125°C

#### Material properties

<b>Main material</b>	Aluminium die-cast
<b>Colour</b>	RAL 9005 black
<b>RoHs conformity</b>	Compliant
<b>China RoHs - EFUP</b>	E
<b>REACH SVHC substances</b>	No

#### Approvals / Standards

<b>Certifications</b>	DNV, BV
<b>UL</b>	ECBT2
<b>cUL</b>	ECBT8

#### General ordering information

<b>EAN13 code</b>	8015747141383
<b>eCl@ss 8.1</b>	27440202
<b>ETIM 7.0</b>	EC000437

#### Packaging Information

<b>Packaging length</b>	160,00 mm
<b>Packaging height</b>	115,00 mm
<b>Packaging width</b>	137,00 mm
<b>Packaging weight</b>	0,78 kg
<b>Packaging volume</b>	2,52 dm <sup>3</sup>
<b>Packaging description</b>	Carton box
<b>Packaging quantity</b>	2 Pcs
<b>Packaging EAN code</b>	8015747142045
<b>Sub-packaging weight</b>	0,39 kg
<b>Sub-packaging description</b>	Plastic packaging
<b>Sub-packaging quantity</b>	1 Pcs
<b>Sub-packaging EAN barcode</b>	8015747142052

Part number

# MGV 10.32 B



Catalogue drawings

**CGO/MGO..B CGV/MGV..B**

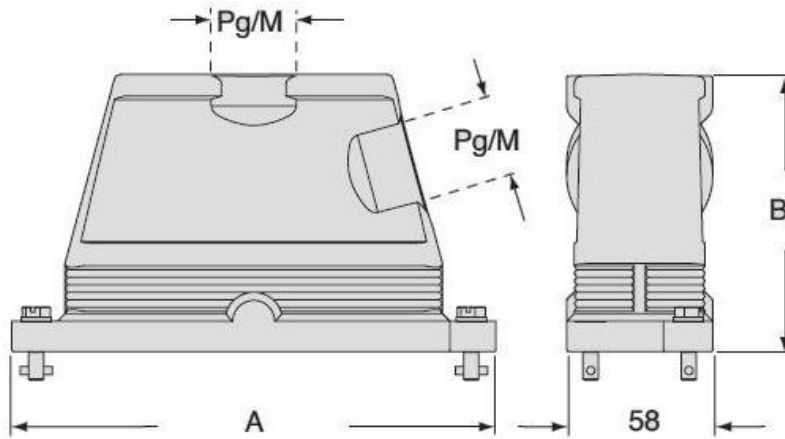

		<b>A</b>	<b>B</b>
<b>CGO/MGO</b>	<b>CGV/MGV 06 B</b>	133	101
<b>CGO/MGO</b>	<b>CGV/MGV 10 B</b>	146	101
<b>CGO/MGO</b>	<b>CGV/MGV 16 B</b>	166	111
<b>CGO/MGO</b>	<b>CGV/MGV 24 B</b>	193	111

## Notes

Dimensions shown in mm are not binding and may be changed without notice.