

Part number

MGO 16.50 B



Hood, IP68 series, with 2 bayonets, M50 side cable entry, size "77.27"

Product description

Product type	Hood
Series	IP68
Closing type	With 2 bayonets
Size	Size "77.27"
Cable entry	Side cable entry with adapter M50

Technical data

IP degree of protection	IP66 / IP68 / IP69
--------------------------------	--------------------

Further technical details

Weight	492,00 g
Operating temperature range (min, max)	-40°C...+125°C

Material properties

Main material	Aluminium die-cast
Colour	RAL 9005 black
RoHs conformity	Compliant
China RoHs - EFUP	E
REACH SVHC substances	No

Approvals / Standards

Certifications	DNV, BV
UL	ECBT2
cUL	ECBT8

General ordering information

EAN13 code	8015747142298
eCl@ss 8.1	27440202
ETIM 7.0	EC000437

Packaging Information

Packaging length	175,00 mm
Packaging height	135,00 mm
Packaging width	130,00 mm
Packaging weight	0,98 kg
Packaging volume	3,07 dm ³
Packaging description	Carton box
Packaging quantity	2 Pcs
Packaging EAN code	8015747142885
Sub-packaging weight	0,49 kg
Sub-packaging description	Plastic packaging
Sub-packaging quantity	1 Pcs
Sub-packaging EAN barcode	8015747142892

Part number

MGO 16.50 B



Catalogue drawings

CGO/MGO..B CGV/MGV..B

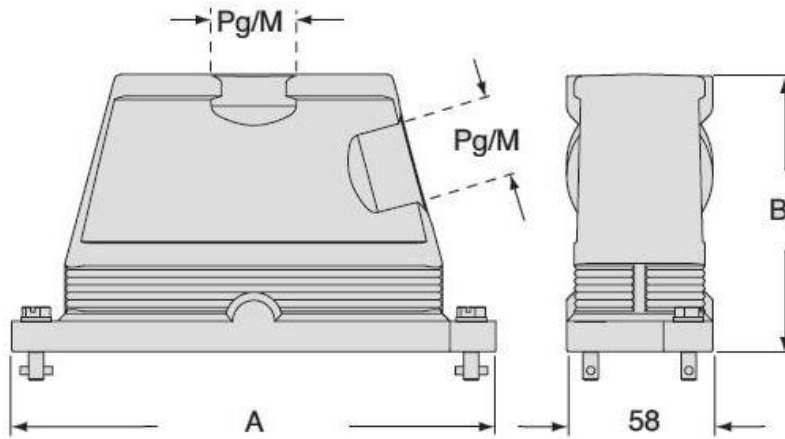

		A	B
CGO/MGO	CGV/MGV 06 B	133	101
CGO/MGO	CGV/MGV 10 B	146	101
CGO/MGO	CGV/MGV 16 B	166	111
CGO/MGO	CGV/MGV 24 B	193	111

Notes

Dimensions shown in mm are not binding and may be changed without notice.