

Part number

MBO 16.40



Hood, BIG series, with 4 pegs, M40 side cable entry, size "77.27"

Product description

Product type	Hood
Series	BIG
Closing type	With 4 pegs
Size	Size "77.27"
Cable entry	Side cable entry with adapter M40

Technical data

IP degree of protection	IP66
--------------------------------	------

Further technical details

Weight	594,50 g
Operating temperature range (min, max)	-40°C...+125°C

Material properties

Colour	RAL 7040 grey
RoHs conformity	Compliant
China RoHs - EFUP	E
REACH SVHC substances	No

Approvals / Standards

Certifications	DNV, BV
UL	ECBT2
cUL	ECBT8

General ordering information

EAN13 code	8015747187176
eCl@ss 8.1	27440202
ETIM 7.0	EC000437

Packaging Information

Packaging length	130,00 mm
Packaging height	145,00 mm
Packaging width	300,00 mm
Packaging weight	3,14 kg
Packaging volume	5,66 dm ³
Packaging description	Carton box
Packaging quantity	4 Pcs
Packaging EAN code	8015747188777
Sub-packaging weight	0,79 kg
Sub-packaging description	Plastic packaging
Sub-packaging quantity	1 Pcs
Sub-packaging EAN barcode	8015747036023

Part number

MBO 16.40



Catalogue drawings

MBO 16

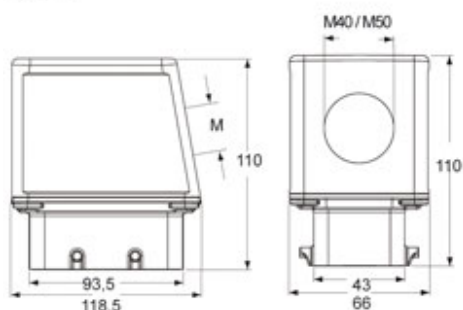

Catalogue drawings

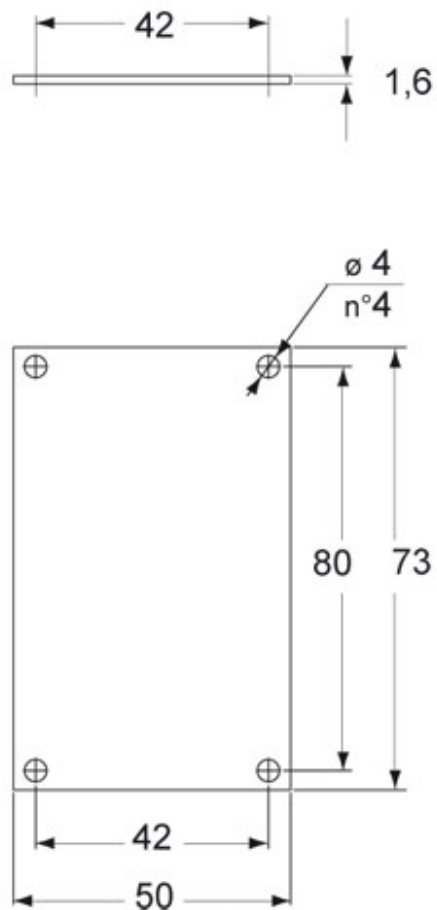

Notes

Dimensions shown in mm are not binding and may be changed without notice.