

Part number

MAV 50 X25



Hood, C-TYPE series, with 2 levers, M25 top cable entry, size "66.40", high construction, without gasket

Product description

Product type	Hood
Series	C-TYPE
Closing type	With 2 levers
Size	Size "66.40"
Cable entry	Top cable entry with adapter M25
Specification	High construction, without gasket

Technical data

IP degree of protection	IP65 / IP66 / IP69
--------------------------------	--------------------

Further technical details

Weight	350,00 g
Operating temperature range (min, max)	-40°C...+125°C

Material properties

Colour	RAL 7040 grey
RoHs conformity	Compliant
China RoHs - EFUP	E
REACH SVHC substances	No
SCIP number	15deaf78-e939-4401-a0b0-e2228ca32a03

Approvals / Standards

Certifications	DNV, BV
UL	ECBT2
cUL	ECBT8

General ordering information

EAN13 code	8015747052917
eCl@ss 8.1	27440202
ETIM 7.0	EC000437

Packaging Information

Packaging length	240,00 mm
Packaging height	120,00 mm
Packaging width	355,00 mm
Packaging weight	3,60 kg
Packaging volume	10,22 dm ³
Packaging description	Carton box
Packaging quantity	10 Pcs
Packaging EAN code	8015747102070

Part number

MAV 50 X25



Catalogue drawings

CHO X (CAO X) - CAV X
MHO X (MAO X/MFO X/MFV X) - MAV X

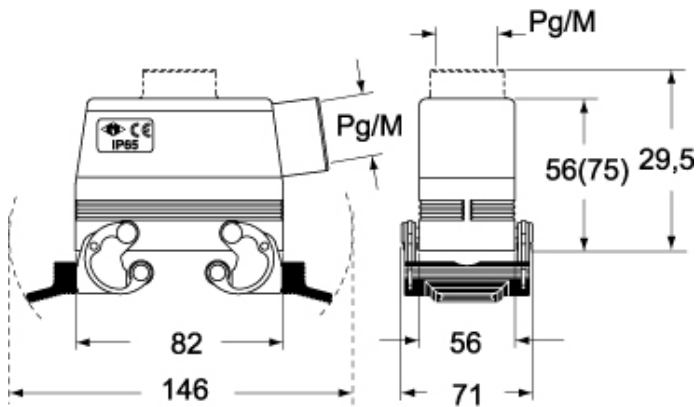

CHC

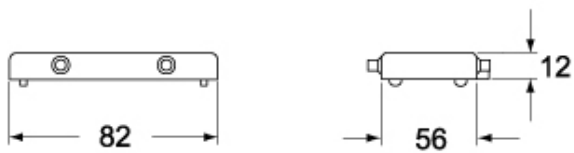

CHC G

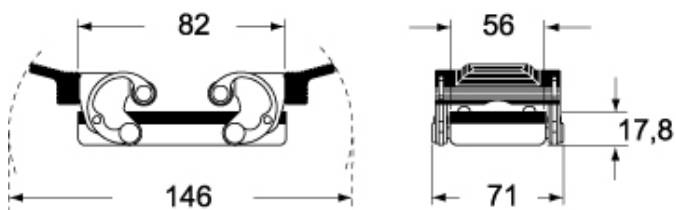

Notes

Dimensions shown in mm are not binding and may be changed without notice.