

Part number

MAPW 16.32



Surface mounting housing, W-TYPE series, with 2 levers, M32 cable entry, size "77.27", high construction

Product description

Product type	Surface mounting housing
Series	W-TYPE
Closing type	With 2 levers
Size	Size "77.27"
Cable entry	M32
Specification	High construction

Technical data

IP degree of protection	IP65 / IP66 / IP69
--------------------------------	--------------------

Further technical details

Weight	448,00 g
Operating temperature range (min, max)	-40°C...+125°C

Material properties

Colour	RAL 9005 black
RoHs conformity	Compliant
China RoHs - EFUP	E
REACH SVHC substances	No

Approvals / Standards

Certifications	DNV, BV
UL	ECBT2
cUL	ECBT8

General ordering information

EAN13 code	8015747098953
eCl@ss 8.1	27440202
ETIM 7.0	EC000437

Packaging Information

Packaging length	475,00 mm
Packaging height	220,00 mm
Packaging width	175,00 mm
Packaging weight	4,88 kg
Packaging volume	18,29 dm ³
Packaging description	Carton box
Packaging quantity	10 Pcs
Packaging EAN code	8015747248365
Sub-packaging weight	2,44 kg
Sub-packaging description	Plastic packaging
Sub-packaging quantity	5 Pcs
Sub-packaging EAN barcode	8015747099141

Part number

MAPW 16.32



Catalogue drawings

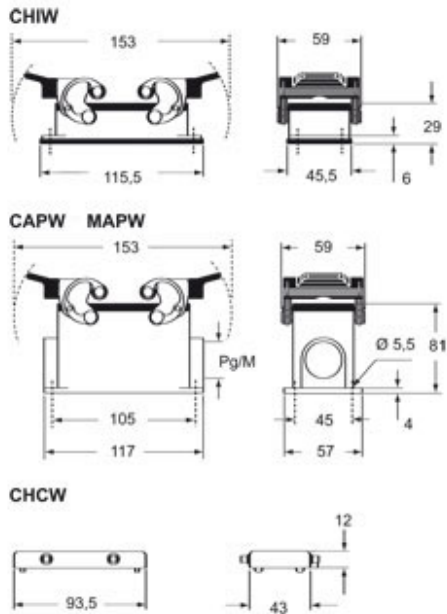

Notes

Dimensions shown in mm are not binding and may be changed without notice.